



Punch200
trans•ana
4-channel

Punch400
trans•ana
4-channel

Punch600
trans•ana
4-channel

Punch800
trans•ana
4-channel

Punch600
trans•ana
5-channel

Installation & Operation

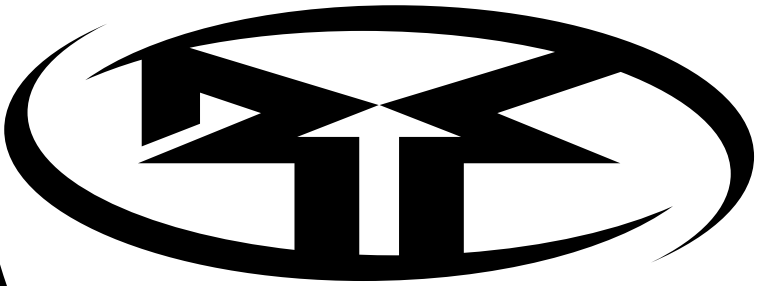

PUNCH

GETTING STARTED

Welcome to Rockford Fosgate! This manual is designed to provide information for the owner, salesperson and installer. For those of you who want quick information on how to install this product, please turn to the **Installation Section** of this manual or refer to the icons listed below. Other information can be located by using the Table of Contents. We, at Rockford Fosgate, have worked very hard to make sure all the information in this manual is current. But, as we are constantly finding new ways to improve our product, this information is subject to change without notice.



Sections marked
INSTALLATION
include "slam dunk"
wiring connections



Sections marked
TROUBLESHOOTING
include recommendations for
curing installation problems

Visit our website for the latest information on all Rockford products.



If, after reading your manual, you still have questions regarding this product, we recommend that you see your Rockford Fosgate dealer. If you need further assistance, you can call us direct at 1-800-669-9899. Be sure to have your serial number, model number and date of purchase available when you call.

The serial number can be found on the outside of the box. Please record it in the space provided below as your permanent record. This will serve as verification of your factory warranty and may become useful in recovering your amplifier if it is ever stolen.

Serial Number: _____

Model Number: _____

Dear Customer,

Congratulations on your purchase of the world's finest brand of car audio amplifiers. At Rockford Fosgate we are fanatics about musical reproduction at its best, and we are pleased you chose our product. Through years of engineering expertise, hand craftsmanship and critical testing procedures, we have created a wide range of products that reproduce music with all the clarity and richness you deserve.

For maximum performance we recommend you have your new Rockford Fosgate product installed by an Authorized Rockford Fosgate Dealer, as we provide specialized training through Rockford Technical Training Institute (RTTI).

Please read your warranty and retain your receipt and original carton for possible future use.

Great product and competent installations are only a piece of the puzzle when it comes to your system. Make sure that your installer is using 100% authentic installation accessories from Connecting Punch in your installation. Connecting Punch has everything from RCA cables and speaker wire to Power line and battery connectors. Insist on it! After all, your new system deserves nothing but the best.

To add the finishing touch to your new Rockford Fosgate image order your Rockford wearables, which include everything from T-shirts and jackets to hats and sunglasses.

To get a free brochure on Rockford Fosgate products and Rockford accessories, in the U.S. call 480-967-3565 or FAX 480-967-8132. For all other countries, call +001-480-967-3565 or FAX +001-480-967-8132.

PRACTICE SAFE SOUND™

CONTINUOUS EXPOSURE TO SOUND PRESSURE LEVELS OVER 100dB MAY CAUSE PERMANENT HEARING LOSS. HIGH POWERED AUTOSOUND SYSTEMS MAY PRODUCE SOUND PRESSURE LEVELS WELL OVER 130dB. USE COMMON SENSE AND PRACTICE SAFE SOUND.

Specifications

	PUNCH 200 4-channel	PUNCH 400 4-channel	PUNCH 600 4-channel	PUNCH 800 4-channel	PUNCH 600 5-channel	
DynamicPowerRating (IHF-202 Standard) - Measured at 14.4 Volts						Front/Rear + Subwoofer
Bridged into a 4Ω Load	165 Watts x 2	220 Watts x 2	317 Watts x 2	525 Watts x 2	240 Watts x 2+	-
Per channel into a 2Ω Load	85 Watts x 4	130 Watts x 4	175 Watts x 4	270 Watts x 4	120 Watts x 4 + 240 Watts x 1	
Per channel into a 4Ω Load	55 Watts x 4	85 Watts x 4	99 Watts x 4	150 Watts x 4	75 Watts x 4 + 115 Watts x 1	
Continuous Power Rating (Competition Standard) - Measured at 13.8 Battery Volts						
RMS continuous power per channel, both channels driven into a 4Ω load from 20 to 20,000 Hz with less than 0.05% Total Harmonic Distortion (THD+N)	25 Watts x 4	50 Watts x 4	75 Watts x 4	100 Watts x 4	50 Watts x 4 + 100 Watts x 1	
RMS continuous power per channel, both channels driven into a 2Ω load from 20 to 20,000 Hz, with less than 0.1% Total Harmonic Distortion (THD+N)	50 Watts x 4	100 Watts x 4	150 Watts x 4	200 Watts x 4	100 Watts x 4 + 200 Watts x 1	
RMS continuous power bridged into a 4Ω load from 20 to 20,000 Hz, with less than 0.1% Total Harmonic Distortion (THD+N)	100 Watts x 2	200 Watts x 2	300 Watts x 2	400 Watts x 2	200 Watts x 2 +	-
Signal-to-Noise Ratio			>100dB A-weighted			
Crossover Slope (Butterworth)	12dB/octave	12dB/octave	12dB/octave	12dB/octave	12dB/octave + 24dB/octave	
Crossover Frequency	80Hz	80Hz	50Hz – 210Hz	50Hz – 210Hz	50Hz – 210Hz + 50Hz – 210Hz	

Specifications are subject to change without notice.

Dimensions	PUNCH 200 4-channel	PUNCH 400 4-channel	PUNCH 600 4-channel	PUNCH 800 4-channel	PUNCH 600 5-channel
	2.4" H (6.09cm)	2.4" H (6.09cm)	2.4" H (6.09cm)	2.4" (6.09cm)	2.4" H (6.09cm)
	9.9" W (25.15cm)	9.9" W (25.15cm)	9.9" W (25.15cm)	9.9" W (25.15cm)	9.9" W (25.15cm)
	13.4" L (34.04cm)	13.4" L (34.04cm)	14.4" L (36.57cm)	18.4" L (46.74cm)	18.4" L (46.74cm)
Frequency Response	20Hz to 20kHz \pm 0.5dB				
Bandwidth	20Hz to 200kHz \pm 3dB				
Damping Factor @ 4 Ω (at output connector)	>200				
Slew Rate	30 Volts/ ms				
THD Distortion (IHF)	<0.05%				
Source Unit Compatibility (+15dB gain overlap)	All	All	All	All	All
Input Sensitivity (+0dB gain overlap)	Variable from 250mV to 4V (low level in) Variable from 650mV to 11V (high level in)				
Protection	NOMAD - Internal analog-computer output protection circuitry limits power in case of overload. Thermal switch shuts down the amplifier in case of overheating.				
Battery Fuse Rating (External to Amplifier)	30A	50A	50A	60A*	50A
Fuse Type	ATC	AGU	AGU	AGU	AGU
Equalization (45Hz Punch Bass)	Variable (0 to +18dB)	Variable (0 to +18dB)	Variable (0 to +18dB)	Variable (0 to +18dB)	Variable (0 to +18dB)
Input Impedance	20k ohms	20k ohms	20k ohms	20k ohms	20k ohms

* recommended fuse not supplied with amplifier

Specifications are subject to change without notice.

Table of Contents

Specifications	ii
Introduction	1
Amplifier Accessory Pack	1
Feature Chart	2
Design Features	4
Installation Considerations	7
Mounting Location	8
Battery and Charging	9
Wiring the System	9
Using Passive Crossovers	11
Table of Component Values	12
Installation	13
System Diagrams	25
Troubleshooting	29
Dynamic Power Measurements	31
Warranty Information	33
International Information	35

Introduction

Rockford engineers designed the Punch multi-channel amplifiers to withstand the rugged automotive environment while delivering superior sound quality in a flexible, reliable, and efficient package. TRANS•ana is a low voltage circuit in the preamp stage of all Punch multi-channel amplifiers that lets the music sound crystal clear and very real, even when played at high volume levels. This is matched with TOPAZ, a unique grounding circuit used to eliminate noise problems associated with car audio systems and their installation. Flexibility is accomplished with the use of high-level inputs and a built-in crossover. The use of a protection circuit called NOMAD, along with MOSFET and DSM (Discrete Surface Mount) and our innovative MEHSA heat dissipating technology improves amplifier efficiency. The result of these components give the Punch amplifier awesome sound quality in a "Bullet Proof" package.

Punch Amplifier Accessory Pack

The accessory pack shipped with the Punch multi-channel amplifiers includes the mounting hardware necessary to secure the amp to the vehicle.

Installation & Operation Manual

Punch Verification Certificate

- (4) Amplifier mounting screws (#8 x 3/4" Phillips)
- (4) Speaker/Power connector set screws (3/32" Allen)
- (4) Endbell mounting screws (9/64" Allen)
- (1) Allen wrench (3/32")
- (1) Allen wrench (9/64")
- (2) High Level Input harness (Punch 200/400/600/800, 4-channel)
 - Replacement part #CC-1992 - 4 position molex
- (1) High Level Input harness (Punch 600, 5-channel)
 - Replacement part #CC-2347 - 8 pin mini-DIN
- (1) Inline fuseholder (except Punch 800, 4-channel)
- (1) ATC 30 amp fuse (Punch 200, 4-channel)
- (1) ATC 50 amp fuse (Punch 400/600, 4-channel & Punch 600, 5-channel)

NOTE: Refer to the specifications section for recommended fuse size on the Punch 800, 4-channel amplifier.

Punch Multi-Channel Amplifier Feature Chart

PUNCH AMPLIFIER MODEL	200	400	600	800	600 F/R + SUB
# of CHANNELS	4	4	4	4	5
RMS Power Stereo (4Ω)	25x4	50x4	75x4	100x4	50x4 + 100x1
RMS Power Stereo (2Ω)	50x4	100x4	150x4	200x4	100x4 + 200x1
RMS Power Bridged (4Ω)	100x2	200x2	300x2	400x2	200x2 + -
Stable Into: (each channel)	2Ω	2Ω	2Ω	2Ω	2Ω + 2Ω
Stable into: (bridged)	4Ω	4Ω	4Ω	4Ω	4Ω + -
CIRCUITRY ¹					
TRANS• <i>ana</i> – circuit topology	X	X	X	X	X
TRANS• <i>nova</i> – patented circuit topology ²	-	-	-	-	-
Class-G – high efficiency topology	-	-	-	-	SUB only
MEHSA – heat dissipating technology	-	X	X	X	X
TOPAZ – patented noise eliminating circuitry ³	X	X	X	X	X
DSM – discrete surface mount	X	X	X	X	X
MOSFETS – power supply & output devices	X	X	X	X	X
NOMAD – protection circuit	X	X	X	X	X
FEATURES					
Die Cast Heatsink	X	X	X	X	X
Hi-Level Inputs – for factory radios	X	X	X	X	F/R only
RCA Inputs – for aftermarket radios	X	X	X	X	X
Balanced Inputs	-	-	-	-	-
Input Switches – eliminates “Y” adaptors	X	X	X	X	X
Pass-Thru – feeds signal to aux. amp	X	X	X	X	-
Pwr/Spk Screw Terminals	-	-	-	-	Spk
Pwr/Spk Block Terminals	X	X	X	X	Pwr
4 Gauge PWR/GND	-	-	-	-	-

PUNCH AMPLIFIER MODEL	200	400	600	800	600
Adjustable Punch Bass (0dB/+6dB/+12dB @ 45Hz)	-	-	-	-	-
Variable Punch Bass (0dB ~+18dB @ 45Hz)	-	-	x	x	x
Adjustable Xover (80Hz)	-	-	-	-	-
Variable Xover (50Hz ~ 210Hz)	HP/FULL/LP ⁴	HP/FULL/LP ⁴	HP/FULL/LP ⁴	HP/FULL/LP ⁴	HP/FULL/LP ⁴
Crossover Slope (Butterworth)	12dB	12dB	12dB	12dB	12dB + 24dB ⁵
Phase Warp (0 ~ 180)	-	-	-	-	-
GENERAL					
B+ Fuse Size	30A ATC	50A AGU	50A AGU	60A AGU ⁶	50A AGU
Dimensions (H x W x L)	2.4" H (6.09cm) 9.9" W (25.15cm) 13.4" L (34.04cm)	2.4" H (6.09cm) 9.9" W (25.15cm) 13.4" L (34.04cm)	2.4" H (6.09cm) 9.9" W (25.15cm) 14.4" L (36.57cm)	2.4"H (6.09cm) 9.9" W (25.15cm) 18.4" L (46.74cm)	2.4" H (6.09cm) 9.9" W (25.15cm) 18.4" L (46.74cm)

--INTERNAL USE ONLY--

Heatsink Type	#4	#4	#5	#6	#6
---------------	----	----	----	----	----

- 1 Additional information on features, specifications and system designs can be found at: www.rockfordfosgate.com
- 2 Trans•nova is patented under "U.S. Patent No. 4,467,288"
- 3 TOPAZ is patented under "U.S. Patent No. 5,751,823"
- 4 HP = 12dB/octave High-Pass / LP = 12dB/octave Low-Pass / FULL = Full Range
- 5 Front/Rear = 12dB/octave + Sub = 24dB/octave Low-Pass
- 6 Recommended fuse not supplied with amplifier

Design Features

Punch 200, 4-channel

Punch 400, 4-channel

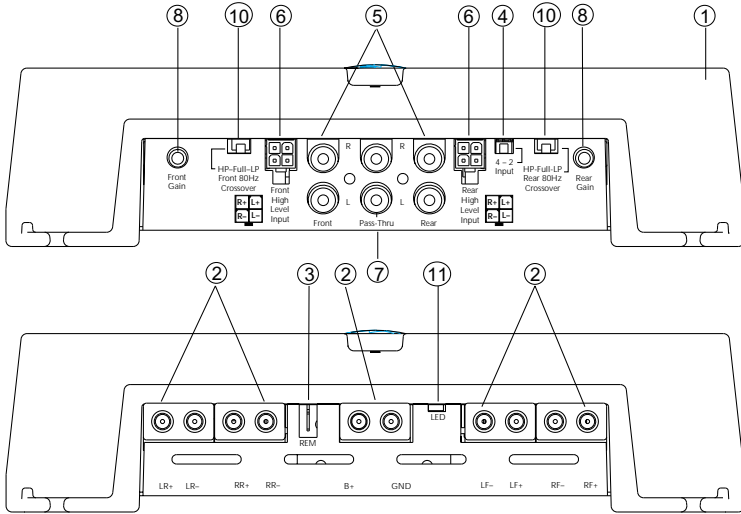

Punch 600, 4-channel

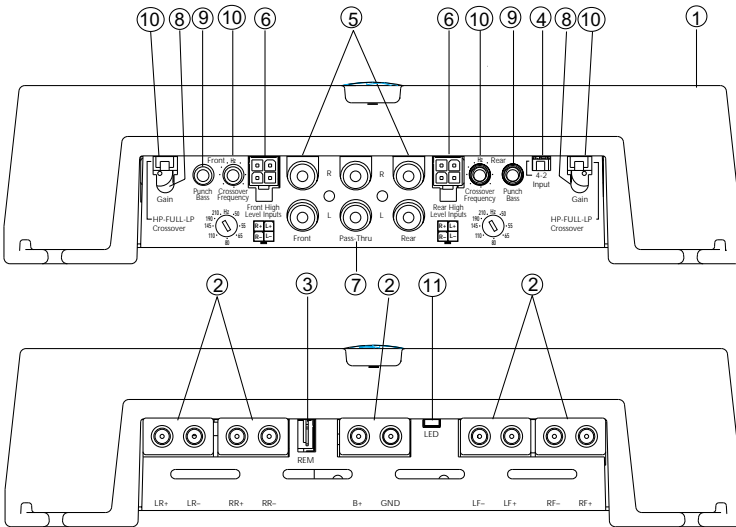

Design Features

Punch 800, 4-channel

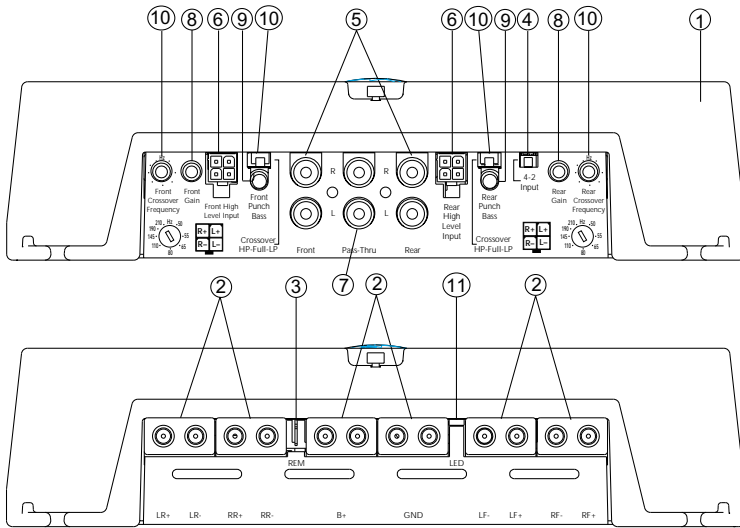

Punch 600, 5-channel

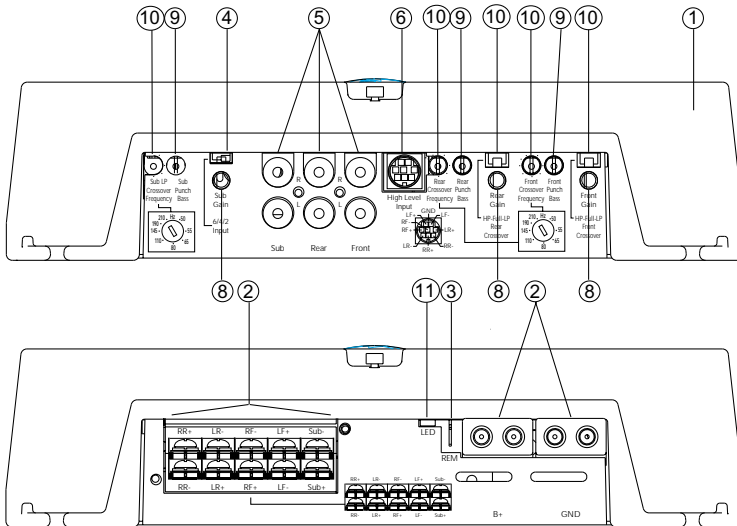

1. **Cast Aluminum Heatsink** – The cast aluminum heatsink of the Punch amplifier dissipates heat generated by the amplifier's circuitry. The inherent advantage of casting provides a 30% improvement of cooling over conventional extrusion heatsink designs.
2. **Speaker/Power Terminals** – The heavy duty, gold-plated terminal block connectors (+ and -) will accept wire sizes from 8 AWG to 18 AWG and are immune to corrosion that can cause signal degradation. The **Punch 600, 5-channel** also utilizes a barrier strip that will accept #8 spade lugs or bare speaker wires sized from 12-18 AWG.
3. **REM Terminal** – This spade terminal is used to remotely turn on and turn off the amplifier when +12V DC is applied.
4. **Signal Input Switch** – This switch allows the amplifier to be driven with either 2 or 4 pairs of inputs. The **Punch 600, 5-channel** allows the amplifier to be driven with either 2, 4, or 6 pairs of inputs.
5. **RCA Input Jacks** – The industry standard RCA jacks provide an easy connection for signal level input. They are gold-plated to resist the signal degradation caused by corrosion.
6. **High Level Inputs** – The high level inputs use a detachable connector terminated with 20 AWG leads. These inputs should be used if the source unit has only speaker line (high level) outputs and not RCA outputs.
7. **RCA Pass-Thru Jacks** – The Pass-Thru provides a convenient source for daisy-chaining an additional amplifier without running an extra set of RCA cables from the front of the vehicle to the rear amplifier location.
8. **Gain Control** – The input gain control is preset to match the output of most source units. It can be adjusted to match output levels from a variety of source units.
9. **Punch Bass** – The Punch Bass helps correct for acoustical deficiencies in the listening environment by helping reproduce full range sound without adding excessive boost. The Punch Bass control is a narrow band adjustment centered at 45Hz variable from 0dB to +18dB.
10. **Internal Crossover** – The internal crossover is a 12dB/octave Butterworth filter selectable for High-Pass (HP), Full Range (FULL), or Low-Pass (LP) operation. The **Punch 200/400, 4-channel** amplifiers utilize a fixed 80Hz crossover. The **Punch 600/800, 4-channel** and **Punch 600, 5-channel** amplifiers utilize a crossover variable from 50Hz to 210Hz with the Sub channel operating at 24dB/octave.
11. **LED Power Indicator** – The LED illuminates when the unit is turned on.

Installation Considerations

The following is a list of tools you will need for installing the Punch amplifier:

Voltmeter	Wire strippers
Electric hand drill w/assorted bits	Battery post wrench
17' (5 m) Red Power Wire	Wire cutters
12' (4 m) Remote Turn-On Wire	Assorted connectors
1.5' (45 cm) Black Grounding Wire	Wire crimpers

This section focuses on some of the vehicle considerations for installing your new Punch amplifier. Checking your battery and present sound system, as well as pre-planning your system layout and best wiring routes, will save installation time. When deciding how to lay out your new system, be sure that each component will be easily accessible for making adjustments.

Before beginning any installation, be sure to follow these simple rules:

1. Be sure to carefully read and understand the instructions before attempting to install the amplifier.
2. **For safety**, disconnect the negative lead from the battery prior to beginning the installation.
3. For easier assembly, we suggest you run all wires prior to mounting your amplifier in place.
4. Route all of the RCA cables close together and away from any high current wires.
5. Use high quality connectors for a reliable installation and to minimize signal or power loss.
6. **Think before you drill!** Be careful not to cut or drill into gas tanks, fuel lines, brake or hydraulic lines, vacuum lines or electrical wiring when working on any vehicle.
7. Never run wires underneath the vehicle. Running the wires inside the vehicle provides the best protection.
8. Avoid running wires over or through sharp edges. Use rubber or plastic grommets to protect any wires routed through metal, especially the firewall.
9. **ALWAYS** protect the battery and electrical system from damage with proper fusing. Install a fuseholder and appropriate fuse on the +12V power wire within 18" (45 cm) of the battery terminal.
10. When grounding to the chassis of the vehicle, scrape all paint from the metal to ensure a good, clean ground connection. Grounding connections should be as short as possible and always be connected to metal that is welded to the main body, or chassis, of the vehicle.

Mounting Location

The mounting location and position of your amplifier will have a great effect on its ability to dissipate the heat generated during normal operation. The design of our cast aluminum heatsink serves to easily dissipate the heat generated over a wide range of operating conditions. However, to maximize the performance of your amplifier, care should be taken to ensure adequate ventilation.

Trunk Mounting

Mounting the amplifier vertically on a surface with the fin grooves running up and down will provide the best cooling of the amplifier.

Mounting the amplifier on the floor of the trunk will work but provides less cooling capability than vertical mounting.

Mounting the amplifier upside down to the rear deck of the trunk will not provide proper cooling and will severely affect the performance of the amplifier and is strongly **not** recommended.

Passenger Compartment Mounting

Mounting the amplifier in the passenger compartment will work as long as you provide a sufficient amount of air for the amplifier to cool itself. If you are going to mount the amplifier under the seat of the vehicle, you must have at least 1" (2.54cm) of air gap around the amplifier's heatsink.

Mounting the amplifier with less than 1" (2.54cm) of air gap around the amplifier's heatsink in the passenger compartment will not provide proper cooling and will severely affect the performance of the amplifier and is strongly **not** recommended.

Engine Compartment Mounting

Rockford Fosgate amplifiers should **never** be mounted in the engine compartment. Not only will this void your warranty but could create an embarrassing situation caused by the ridicule from your friends.

Battery and Charging

Amplifiers will put an increased load on the vehicle's battery and charging system. We recommend checking your alternator and battery condition to ensure that the electrical system has enough capacity to handle the increased load of your stereo system. Stock electrical systems which are in good condition should be able to handle the extra load of any Rockford amplifier without problems, although battery and alternator life can be reduced slightly. To maximize the performance of your Rockford Fosgate amplifier, we suggest the use of a heavy duty battery and an energy storage capacitor.

Wiring the System

CAUTION: Avoid running power wires near the low level input cables, antenna, power leads, sensitive equipment or harnesses. The power wires carry substantial current and could induce noise into the audio system.

1. Plan the wire routing. Take care when running signal level RCA cables to keep them close together but isolated from the amplifier's power cables and any high power auto accessories, especially electric motors. This is done to prevent coupling the noise from radiated electrical fields into the audio signal. When feeding the wires through the firewall or any metal barrier, protect them with plastic or rubber grommets to prevent short circuits. Leave the wires long at this point to adjust for a precise fit at a later time.

2. Prepare the **Power** cable for attachment to the amplifier by stripping 5/8" of insulation from the end of the wire. The use of 8 gauge power cable can interfere with the installation of the end caps. Proper wire dress can prevent this from occurring. To prevent the wire from fraying, strip the insulation at a 45° angle. Insert the bared wire into the B+ terminal with the long side of the insulation on the top. Bend the cable down at a 90° angle. Tighten the set screw to secure the cable in place.

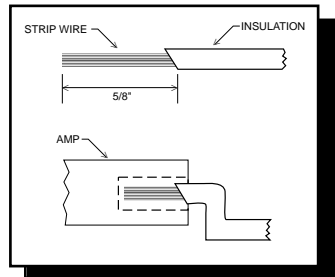

3. Strip 3/8" from the battery end of the power cable and crimp a large ring terminal to the cable. Use the ring terminal to connect to the battery positive terminal. **Do not install the fuse at this time.**

4. Prepare a length of cable to be used for the ground connection. Strip 5/8" of insulation from the end of the cable as described above and connect to the appropriate terminal of the amplifier. Prepare the chassis ground by scraping any paint from the metal surface and thoroughly clean the area of all dirt and grease. Strip the other end of the wire and attach a ring connector. Fasten the cable to the chassis using a non-anodized screw and a star washer.
5. Prepare the REM turn-on wire for connection to the amplifier by stripping 1/4" of insulation from the wire end and crimping an insulated spade connector in place. Slide the connector over the REM terminal on the amplifier. Connect the other end of the REM wire to a switched 12 volt positive source. The switched signal is usually taken from the source unit's auto antenna or the accessory lead. If the source unit does not have these outputs available, the recommended solution is to wire a mechanical switch in line with a 12 volt source to activate the amplifier.
6. Securely mount the amplifier (with supplied screws) to the vehicle or amp rack. Be careful not to mount the amplifier on cardboard or plastic panels. Doing so may enable the screws to pull out from the panel due to road vibrations or sudden vehicle stops.
7. Determine the number of inputs needed to drive the amplifier and move the input switch to the desired setting.
8. Connect the source signal to the amplifier by plugging the RCA cables or high level inputs into the input jack(s) at the amplifier.
9. Connect the speakers. Strip the speaker wires 5/8" and insert into the appropriate terminal on the amplifier. Insert the bared wire into the speaker terminal and tighten the set screw to secure into place. Be sure to maintain proper speaker polarity. ***DO NOT chassis ground any of the speaker leads as unstable operation may result.***
10. Perform a final check of the completed system wiring to ensure that all connections are accurate. Check all power and ground connections for frayed wires and loose connections which could cause problems from road vibrations.

Using Passive Crossovers

A passive crossover is a circuit that uses capacitors and/or coils and is placed on speaker leads between the amplifier and speaker. The crossover delegates a specific range of frequencies to the speaker for optimum driver performance. A crossover network can perform one of three functions: High-Pass (capacitors), Low-Pass (inductors or coils) and Bandpass (combination of capacitor and coil).

The most commonly used passive crossover networks are 6dB/octave systems. These are easy to construct and require one component per filter. Placing this filter in series with the circuit will reduce power to the speaker by 6dB/octave above or below the crossover point depending on whether it is a high-pass or low-pass filter. More complex systems such as 12dB/octave or 18dB/octave can cause impedance problems if not professionally designed.

Passive crossovers are directly dependent upon the speaker's impedance and component value for accuracy. When passive crossover components are used in multiple speaker systems, the crossover's effect on the overall impedance should be taken into consideration along with the speaker's impedance when determining amplifier loads. ***CAUTION: The Punch amplifiers are not recommended for impedance loads below 2Ω stereo and 4Ω bridged (mono) loads.***

Table of Crossover Component Values

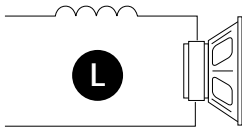

6dB/Octave Low-Pass

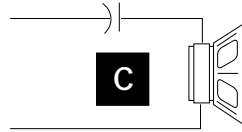

6dB/Octave High-Pass

Freq. Hertz	Speaker Impedance					
	2 OHMS		4 OHMS		8 OHMS	
	L	C	L	C	L	C
80	4.1mH	1000µF	8.2mH	500µF	16mH	250µF
100	3.1mH	800µF	6.2mH	400µF	12mH	200µF
130	2.4mH	600µF	4.7mH	300µF	10mH	150µF
200	1.6mH	400µF	3.3mH	200µF	6.8mH	100µF
260	1.2mH	300µF	2.4mH	150µF	4.7mH	75µF
400	.8mH	200µF	1.6mH	100µF	3.3mH	50µF
600	.5mH	136µF	1.0mH	68µF	2.0mH	33µF
800	.41mH	100µF	.82mH	50µF	1.6mH	26µF
1000	.31mH	78µF	.62mH	39µF	1.2mH	20µF
1200	.25mH	66µF	.51mH	33µF	1.0mH	16µF
1800	.16mH	44µF	.33mH	22µF	.68mH	10µF
4000	.08mH	20µF	.16mH	10µF	.33mH	5µF
6000	51µH	14µF	.10mH	6.8µF	.20mH	3.3µF
9000	34µH	9.5µF	68µH	4.7µF	.15mH	2.2µF
12000	25µH	6.6µF	51µH	3.3µF	100µH	1.6µF

L = Low-Pass (Inductor)

C = High-Pass (Capacitor)

For more information, see your Authorized Rockford Fosgate Dealer.

Installation



The Punch Multi-Channel amplifier inputs can be used with radios that have either RCA (low-level) preamp outputs or Speaker (high-level) outputs.

Using RCA Inputs - or- High Level Inputs

- Punch 200, 4-channel
- Punch 400, 4-channel
- Punch 600, 4-channel
- Punch 800, 4-channel

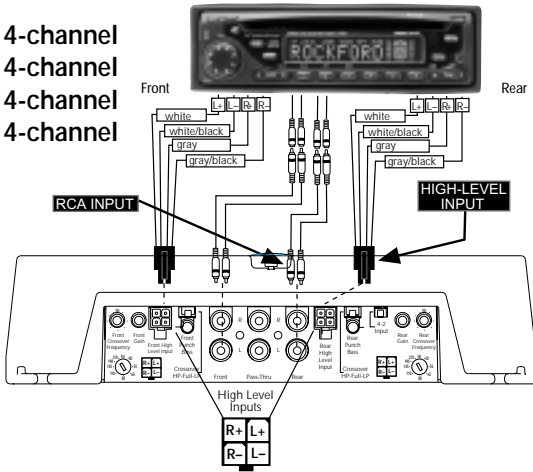

Using RCA Inputs - or- High Level Inputs

Punch 600, 5-channel
 nel

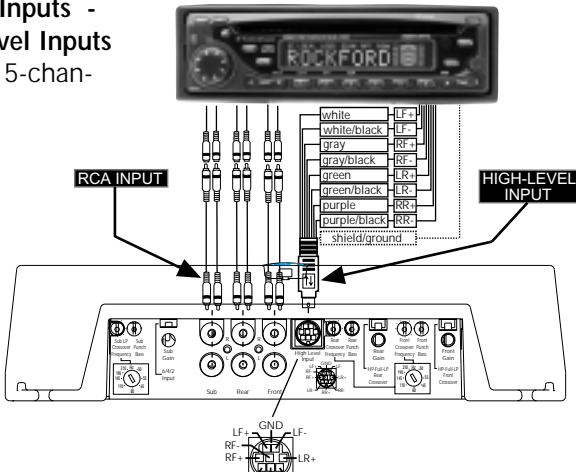

- **RCA Inputs** connect to radio's RCA preamp outputs
- **High Level Inputs** connect directly to radio's speaker outputs

NOTE: When using High Level Inputs on the Punch 600, 5-channel amplifier, signal from the Front/Rear inputs are summed to provide a Subwoofer input.

CAUTION: Use only one input configuration to prevent damage to the



Crossover Operation
Punch 600, 4-channel
Punch 800, 4-channel
Punch 600, 5-channel

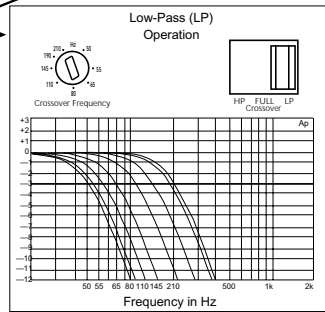
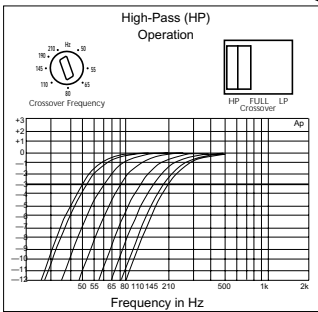
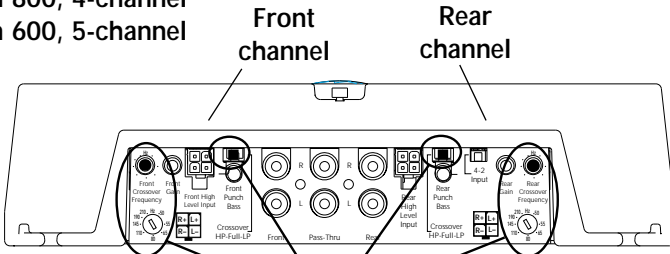

- **HP Operation** enables frequencies above the cut-off point to pass to the speaker
- **FULL Operation** enables all frequencies to pass to the speaker
- **LP Operation** enables frequencies below the cut-off point to pass to the speaker

NOTE: The **Punch 200, 4-channel** & **Punch 400, 4-channel** amplifiers utilize a fixed 80Hz crossover with HP, FULL & LP configurations.



Punch Bass Operation

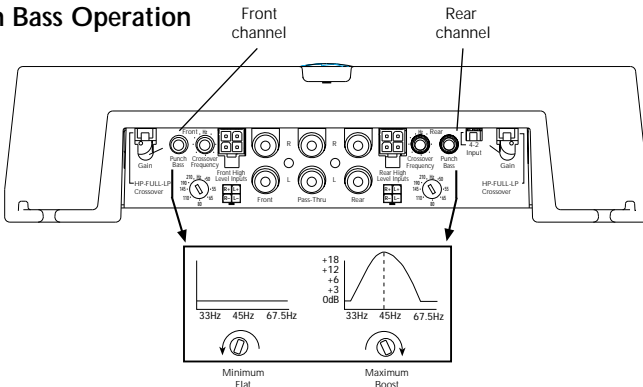

- Carefully increase potentiometer to add Punch to your bass frequencies
- Exercise caution when increasing Punch Bass. Maximum boost can cause potential woofer damage caused by overexcursion

Pass-Thru

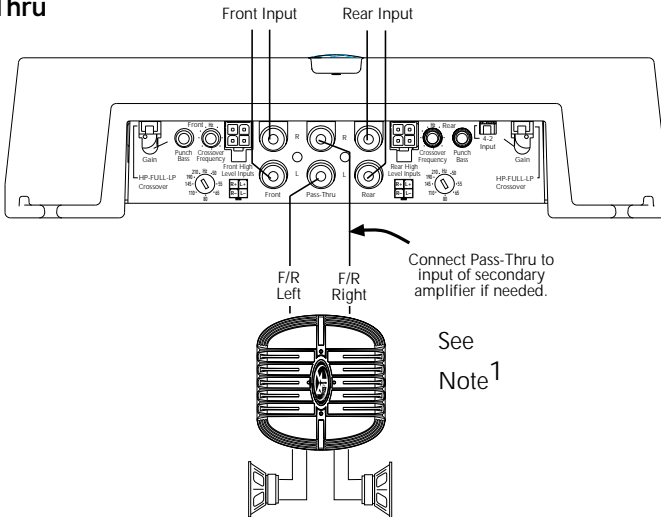

- **Pass-Thru** feeds signal to secondary amplifier
- **Signal from Pass-Thru** remains stereo

Note¹: If using High Level Inputs causes engine whine in an amplifier connected to the Pass-Thru, the Pass-Thru amplifier should have its RCA input shield connected to the radio chassis ground. Refer to the Troubleshooting section of this manual for more information.



Power Connections

Punch 200, 4-channel
Punch 400, 4-channel
Punch 600, 4-channel

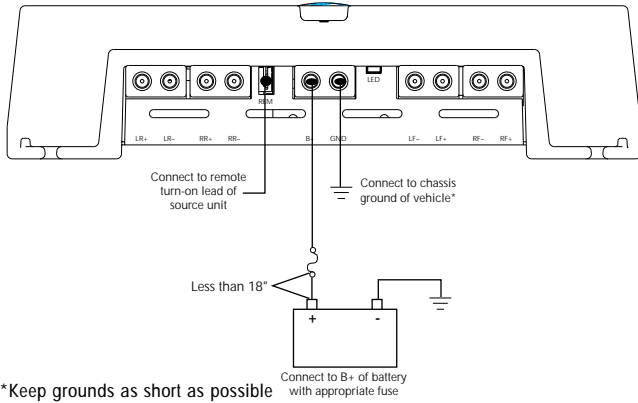

Power Connections

Punch 800, 4-channel

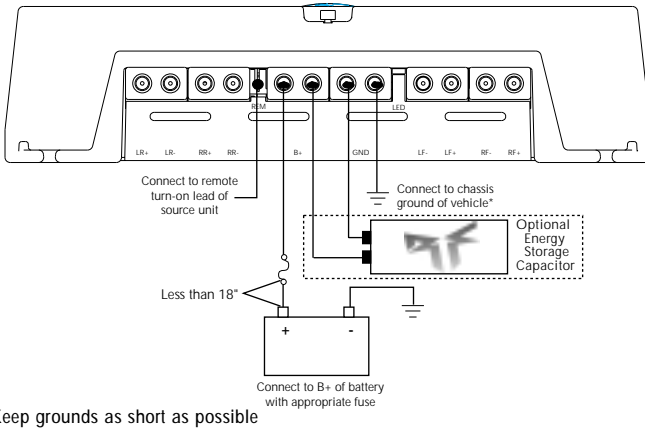



Power Connections Punch 600, 5-channel

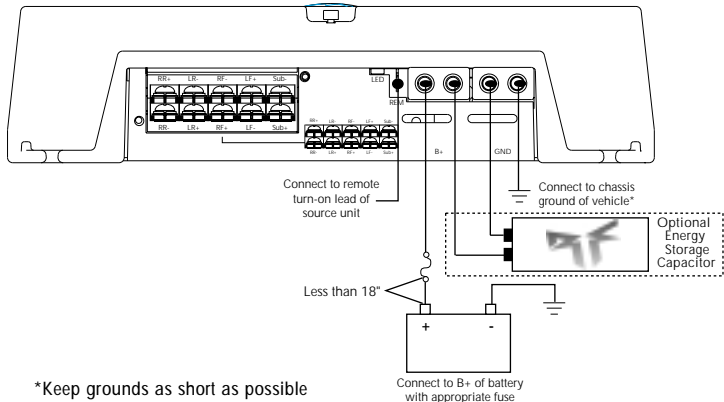



2-Channel Mode

Punch 200, 4-channel

Punch 400, 4-channel

Punch 600, 4-channel

Punch 800, 4-channel

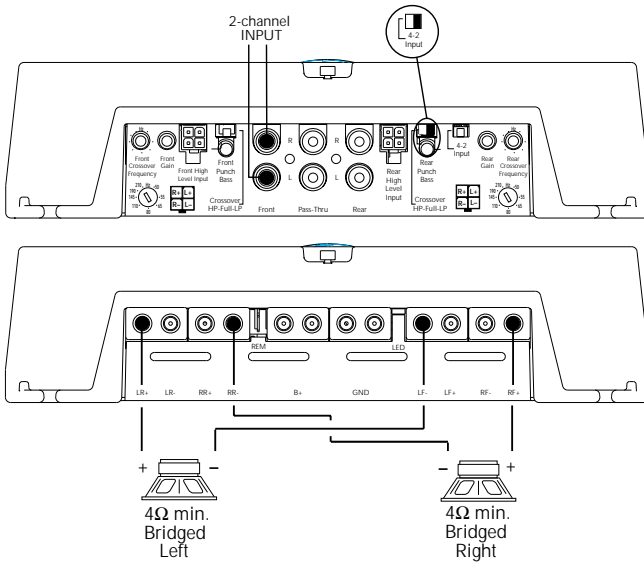

NOTE: The Punch 800, 4-channel amplifier side views are used to illustrate wiring configurations for all amplifiers

- **RCA Inputs** are connected to front inputs
- **4-2 Input Switch** is set to 2-channel input mode
- **Gain** for front and rear channels must be set identical
- **Speaker Impedance** for each bridged channel should be no less than 4Ω

NOTE: Punch 200/400, 4-channel amplifiers

- **80Hz Crossovers** for front and rear channels must be set to identical operating mode (i.e. both set to LP)

NOTE: Punch 600/800, 4-channel amplifiers

- **Variable Crossovers** for front and rear channels must be set to identical frequency (i.e. both set to 60Hz) and operating mode (i.e. both set to LP)



2-Channel Mode Punch 600, 5-channel

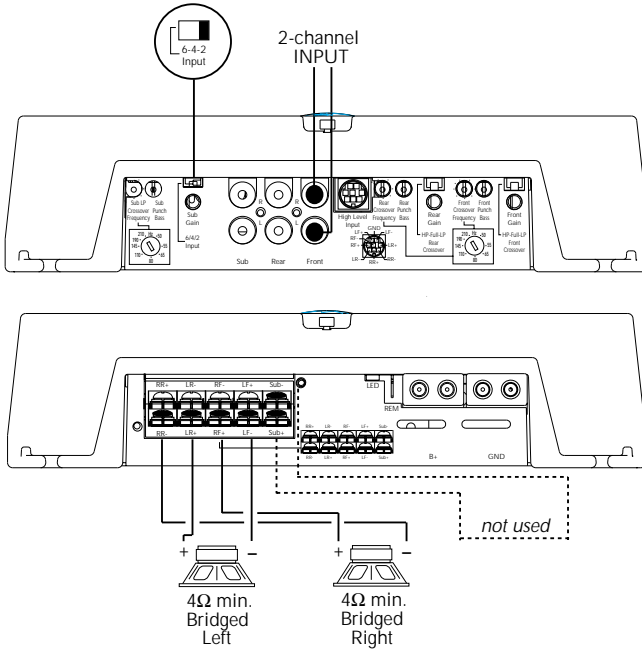

- **RCA Inputs** are connected to front inputs
- **6-4-2 Input Switch** is set to 2-channel input mode
- **Gain** for front and rear channels must be set identical
- **Speaker Impedance** for each bridged channel should be no less than 4Ω
- **Variable Crossovers** for front and rear channels must be set to identical frequency (i.e. both set to 60Hz) and operating mode (i.e. both set to LP)



3-Channel Mode

Punch 200, 4-channel

Punch 400, 4-channel

Punch 600, 4-channel

Punch 800, 4-channel

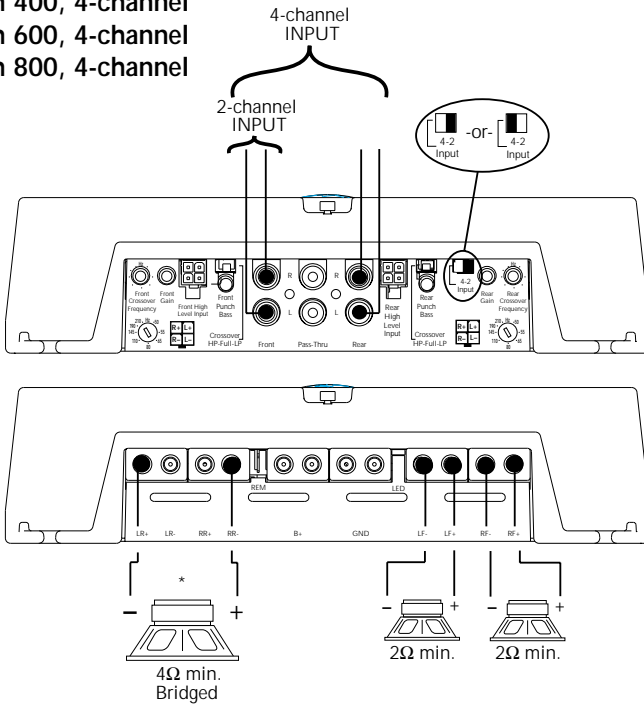

NOTE: The Punch 800, 4-channel amplifier side views are used to illustrate wiring configurations for all amplifiers

- **RCA Inputs** are connected to front -or- front/rear inputs
 - **4-2 Input Switch** is set to 2-channel -or- 4-channel input mode
 - **Gain** for front and rear channels operate independently
 - **Speaker Impedance** for each stereo front channel should be no less than 2Ω
 - **Speaker Impedance** for rear bridged channel should be no less than 4Ω
- * Reverse polarity on subwoofer if front channel is set to HP (High-Pass) and rear channel is set to LP (Low-Pass)

NOTE: Punch 200/400, 4-channel amplifiers

- **80Hz Crossovers** for front & rear can be set to HP (High-Pass), LP (Low-Pass) or FULL (Full Range)

NOTE: Punch 600/800, 4-channel amplifiers

- **Variable Crossovers** for front & rear are variable from 50Hz~210Hz and can be set to HP (High-Pass), LP (Low-Pass) or FULL (Full Range)



3-Channel Mode Punch 600, 5-channel

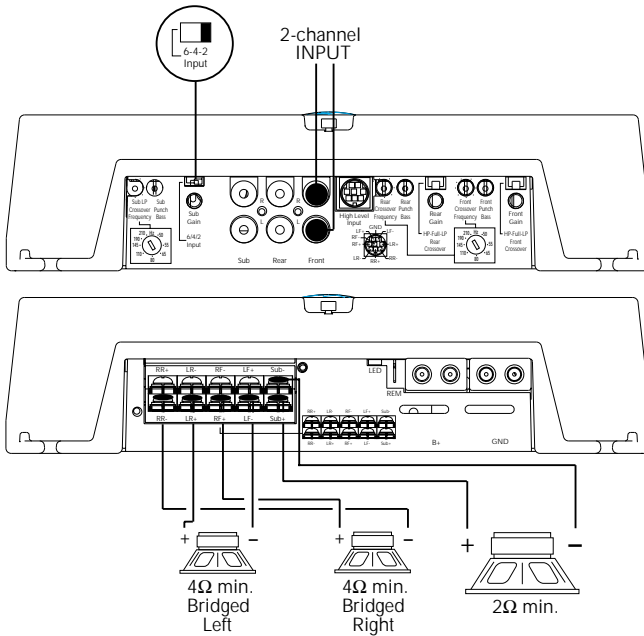

- **RCA Inputs** are connected to front inputs
- **6-4-2 Input Switch** is set to 2-channel input mode
- **Gain** for front & rear channels must be set identical
- **Gain** for sub channel operates independently
- **Speaker Impedance** for each bridged channel should be no less than 4Ω
- **Speaker Impedance** for single channel sub should be no less than 2Ω
- **Variable Crossovers** for front and rear channels must be set to identical frequency (i.e. both set to 60Hz) and operating mode (i.e. both set to LP)
- **Variable Crossover** for sub channel operates as a dedicated LP (Low-Pass) crossover



4-Channel Mode

Punch 200, 4-channel

Punch 400, 4-channel

Punch 600, 4-channel

Punch 800, 4-channel

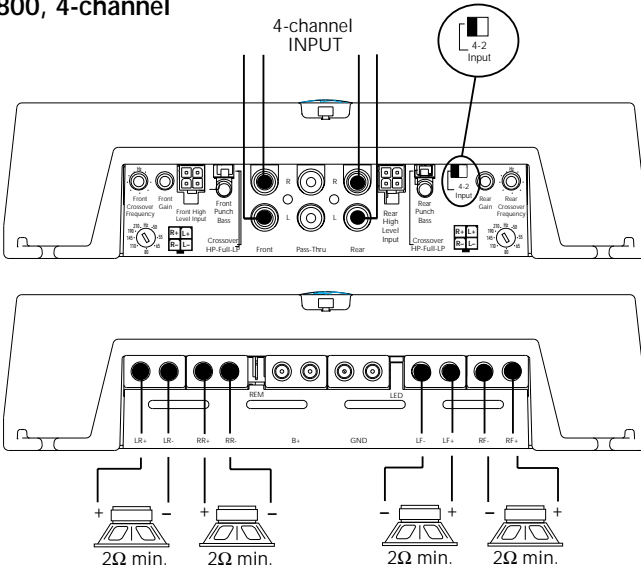

NOTE: The Punch 800, 4-channel amplifier side views are used to illustrate wiring configurations for all amplifiers

- **RCA Inputs** are connected to front & rear inputs
- **4-2 Input Switch** is set to 4-channel input mode
- **Gain** for front and rear channels operate independently
- **Speaker Impedance** for all stereo channels should be no less than 2Ω

NOTE: Punch 200/400, 4-channel amplifiers

- **80Hz Crossovers** can be set to HP (High-Pass), LP (Low-Pass) or FULL (Full Range)

NOTE: Punch 600/800, 4-channel amplifiers

- **Variable Crossovers** for front & rear are variable from 50Hz~210Hz and can be set to HP (High-Pass), LP (Low-Pass) or FULL (Full Range)



4-Channel Mode Punch 600, 5-channel

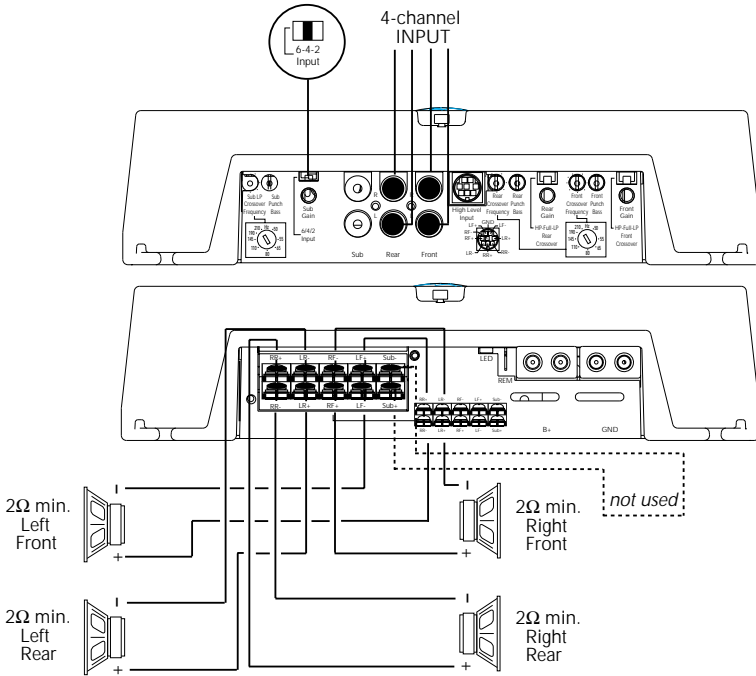

- **RCA Inputs** are connected to front & rear inputs
- **6-4-2 Input Switch** is set to 4-channel input mode
- **Gain** for front and rear channels operate independently
- **Speaker Impedance** for all stereo channels should be no less than 2Ω
- **Variable Crossovers** for front & rear are variable from 50Hz-210Hz and can be set to HP (High-Pass), LP (Low-Pass) or FULL (Full Range)
- **Variable Crossover** for sub channel operates as a dedicated LP (Low-Pass) crossover



5-Channel Mode Punch 600, 5-channel

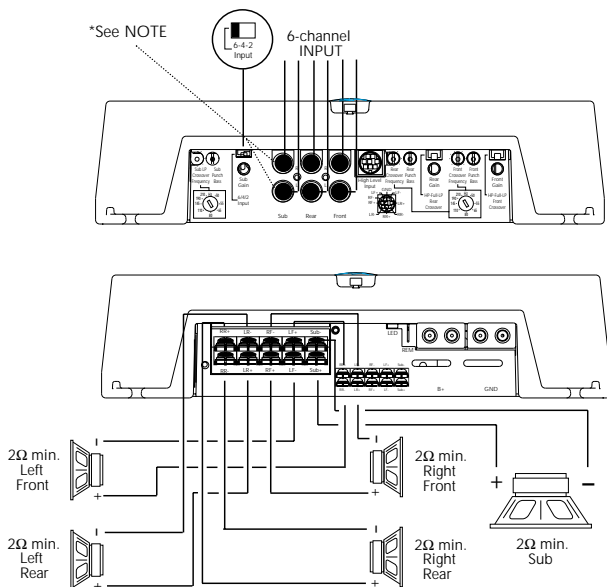

- **RCA Inputs** are connected to front, rear & sub inputs
- **6-4-2 Input Switch** is set to 6-channel input mode
**NOTE: Inputs #5 & #6 (sub inputs) provide a summed-mono signal for the sub channel*
- **Gain** for front, rear & sub channels operate independently
- **Speaker Impedance** for front/rear stereo channels should be no less than 2Ω
- **Speaker Impedance** for single channel sub should be no less than 2Ω
- **Variable Crossovers** for front & rear are variable from 50Hz~210Hz and can be set to HP (High-Pass), LP (Low-Pass) or FULL (Full Range)
- **Variable Crossover** for sub channel operates as a dedicated LP (Low-Pass) crossover

System Diagrams

200 Watt 3-Way System

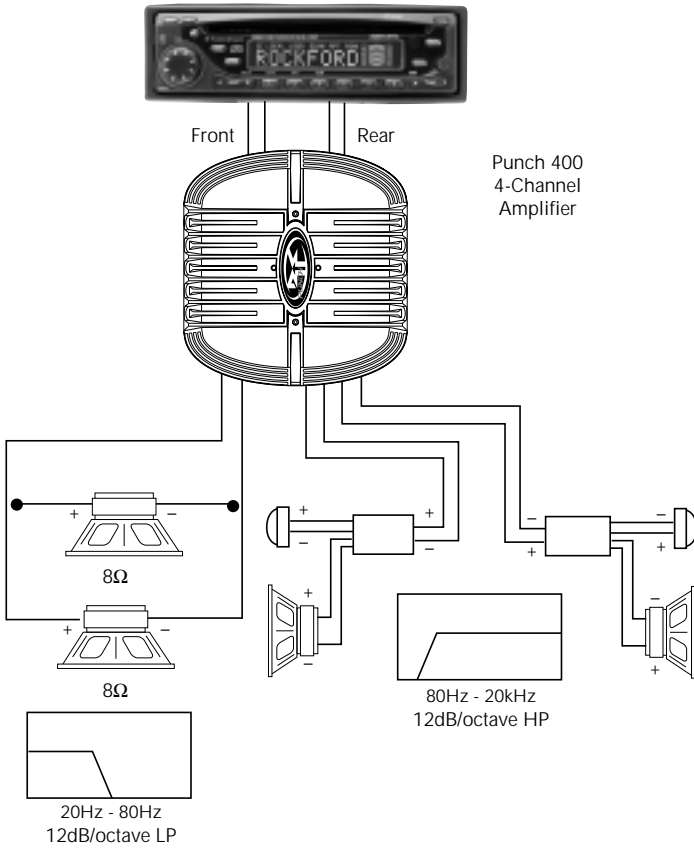

325 Watt 4-Way System

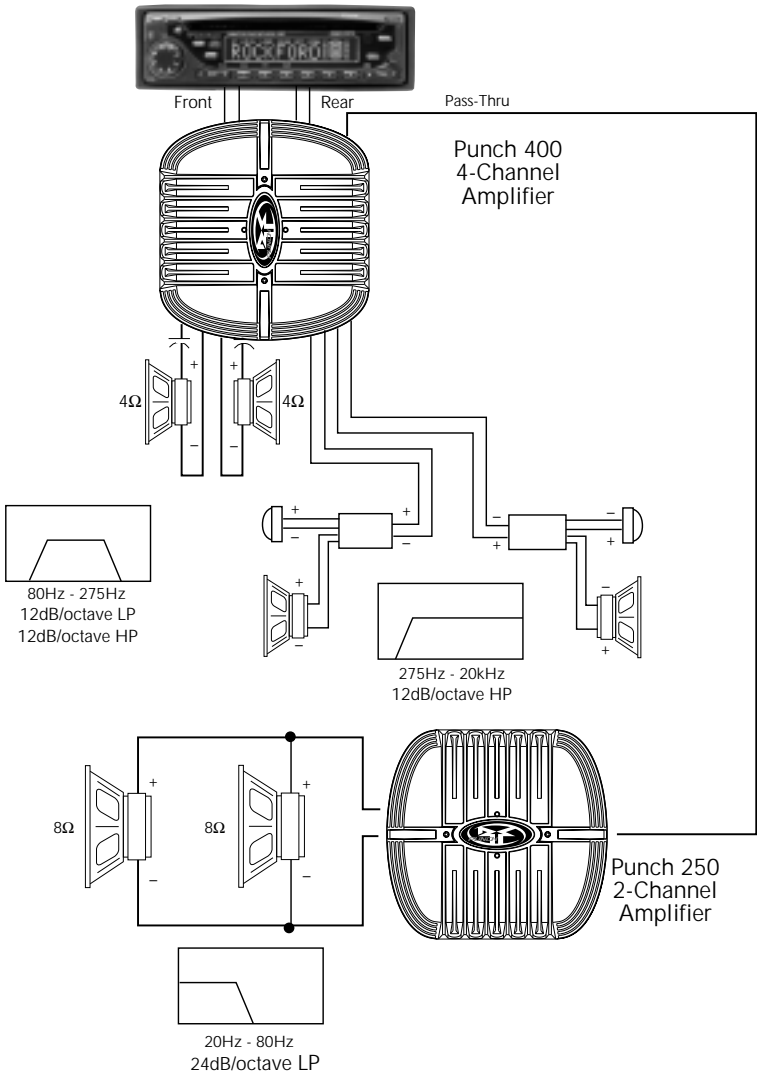

525 Watt 4-Way System

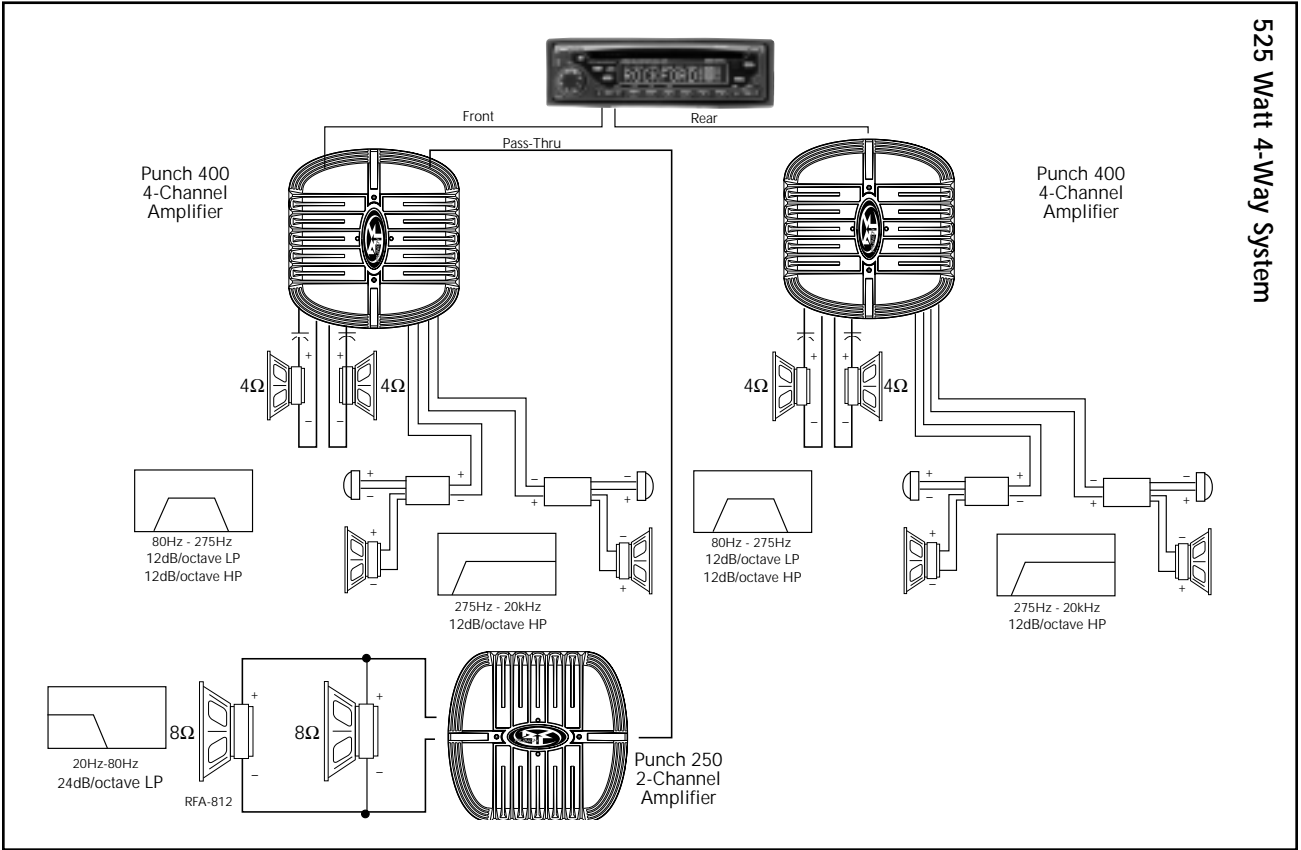

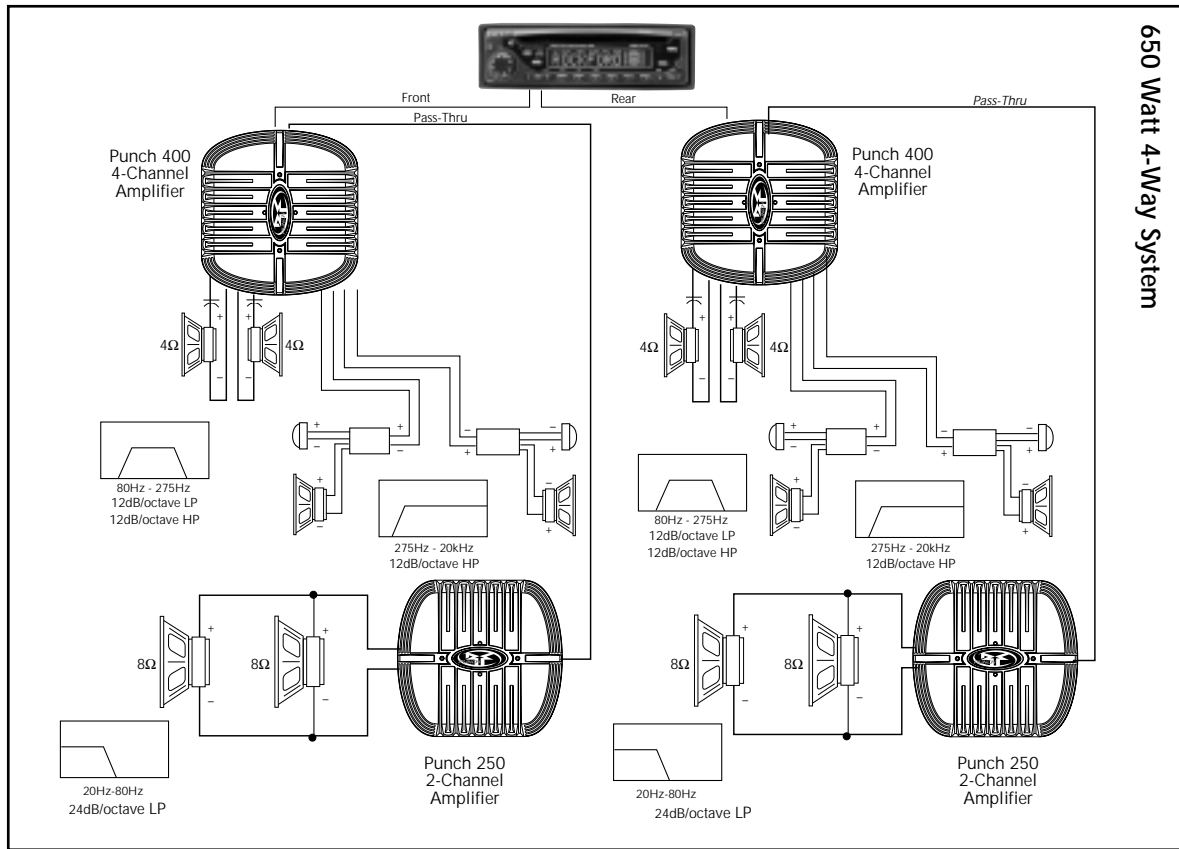

Troubleshooting



If you are having problems after installation follow the Troubleshooting procedures below.

Procedure 1: Check Amplifier for proper connections.

Verify that POWER light is on. If POWER light is on skip to Step 2, if not continue.

1. Check in-line fuse on battery positive cable. Replace if necessary.
2. Verify that Ground connection is connected to clean metal of the vehicle's chassis. Repair/replace if necessary.
3. Verify there is 10.5 - 15.5 Volts of current present at the positive battery and remote turn-on cable. Verify quality connections for both cables at amplifier, stereo, and battery/fuseholder. Repair/replace if necessary.

Procedure 2: Check Amplifier for audio output.

1. Connect a single 4 or 8 ohm test speaker directly to each output channel amplifier. Verify speakers in car are good and wiring between amplifier and speakers, including connectors are good. Repair/replace if necessary.
2. Verify good RCA/high-level input connections at stereo and amplifier. Check entire length of cables for kinks, splices, etc. Test RCA/high-level inputs for AC current with stereo on. Repair/replace if necessary.
3. Disconnect RCA/high-level input from amplifier. Connect RCA/high-level input from test stereo directly to amplifier input.

Procedure 3: Check Amplifier if you experience Turn-on Pop.

1. Disconnect input signal to amplifier and turn amplifier on and off.
2. If the noise is eliminated, connect the REM lead of amplifier to source unit with a delay turn-on module.

OR

1. Use a different 12 Volt source for REM lead of amplifier (i.e. battery direct).
2. If the noise is eliminated, use a relay to isolate the amplifier from noisy turn-on output.



Procedure 4: Check Amplifier if you experience excess Engine Noise.

1. Route all signal carrying wires (RCA, Speaker cables) away from power and ground wires.

OR

2. Bypass any and all electrical components between the stereo and the amplifier(s). Connect stereo directly to input of amplifier. If noise goes away the unit being bypassed is the cause of the noise.

OR

3. Remove existing ground wires for all electrical components. Reground wires to different locations. Verify that grounding location is clean, shiny metal free of paint, rust etc.

OR

4. Add secondary ground cable from negative battery terminal to the chassis metal or engine block of vehicle.

OR

5. Have alternator and battery load tested by your mechanic. Verify good working order of vehicle electrical system including distributor, spark plugs, spark plug wires, voltage regulator etc.

Dynamic Power Measurements

About the Dynamic Power Measurements

The Audio Graph PowerCube is a test instrument used to measure the output of an amplifier in accordance with IHF-202 industry standards. The IHF-202 standard is a dynamic power measurement and was developed as a means of measuring power in a manner that best represents the Real World operation of an amplifier. Many manufacturers, including Rockford Fosgate, at times will measure amplifier power into a fixed resistor (4 ohm, 2 ohm). While this method is useful in some types of evaluation and testing, it is not representative of an amplifier that is connected to a speaker and playing music.

Music

Music is dynamic; the sound waves are complex and constantly changing. In order to simulate this, the IHF-202 standard calls for the input signal to the amplifier to be a 1kHz burst tone. This signal is input (on for 20 milliseconds) and reduced 20dB for 480 milliseconds. The signal is gradually increased in level until the amplifier's output exceeds 1% Total Harmonic Distortion (THD). At 1% distortion becomes audible, therefore, any power produced above that level is considered *unusable*. Many manufacturers represent their amplifiers' output power in excess of 10% distortion. They use many names for this measurement, such as Total Maximum Power or Maximum Output Power. This is not indicative of the *actual usable output power*.

Listening to Loudspeakers - Not Resistors

A loudspeaker is not a resistor. A resistor's value (resistance measured in ohms) is fixed. A loudspeaker's impedance is dynamic. It is constantly changing in value, dependent upon the frequency of the input signal. Therefore, measuring power with the amplifier loaded into a 4 ohm resistor is not the same as measuring power with the amplifier connected to a 4 ohm speaker. Most people do not listen to music through a resistor.

A 4 ohm speaker may experience a drop in impedance 4-6 times lower than its nominal (printed) impedance. A speaker will also create phase shifts in the signal that is passed through it. These phase shifts happen because a speaker is an inductor (voice coil) and a capacitor (compliance of the surround/spider), as well as a resistor (voice coil wire).

To simulate a speaker the Audio Graph PowerCube measures output power into 20 different loads. It tests at 8 ohms, 4 ohms, 2 ohms and 1 ohm. Each of these impedances is also tested at -60° , -30° , 0° , $+30^\circ$ and $+60^\circ$ phase angles. These different impedances and phase angles represent the shifts in impedance and phase that can occur in a typical loudspeaker.

Information Cubed

The data acquired in the testing procedure is then graphed in the form of a 3-dimensional cube, hence the name **PowerCube**.

The *Phase Angle* is expressed on the horizontal axis, the *Output Voltage* is presented on the vertical axis and the *Impedance* is displayed on the Z axis. *Output Power*, in watts, is listed on the left hand side for each impedance at each phase angle.

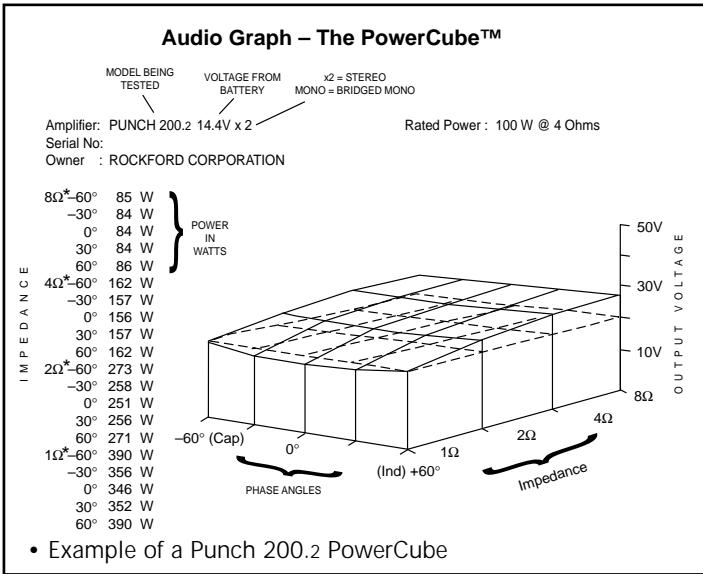

What is an Amplifier?

An amplifier by definition is a voltage generating device, recreating the signal which is input to it identically but with increased volume. It will be connected to a reactive load (the speaker). The impedance of this load and phase of the signal passing through the load will vary, dependent upon the frequency of the input signal (music).

Therefore, a perfect amplifier will be able to maintain the same output voltage regardless of load characteristics and will not alter the signal it is reproducing. A perfect amplifier when measured by the Audio Graph PowerCube would present data that forms a perfect cube. Unfortunately, amplifiers are not perfect. The laws of physics generally prevent it. A great amplifier is about the best one can hope to attain.

As you can see by the PowerCube and as you will experience by listening, your Punch amplifier is a GREAT AMPLIFIER!

Limited Warranty Information

Rockford Corporation offers a limited warranty on Rockford Fosgate products on the following terms:

- **Length of Warranty**

3 years on electronics (receipt required)	90 days on electronic B-stock (receipt required)
2 years on source units	90 days on speaker B-stock (receipt required)
1 year on speakers	
- **What is Covered**

This warranty applies only to Rockford Fosgate products sold to consumers by Authorized Rockford Fosgate Dealers in the United States of America or its possessions. Product purchased by consumers from an Authorized Rockford Fosgate Dealer in another country are covered only by that country's Distributor and not by Rockford Corporation.
- **Who is Covered**

This warranty covers only the original purchaser of Rockford product purchased from an Authorized Rockford Fosgate Dealer in the United States. In order to receive service, the purchaser must provide Rockford with a copy of the receipt stating the customer name, dealer name, product purchased and date of purchase.
- **Products found to be defective** during the warranty period will be repaired or replaced (with a product deemed to be equivalent) at Rockford's discretion.
- **What is Not Covered**
 1. Damage caused by accident, abuse, improper operations, water, theft
 2. Any cost or expense related to the removal or reinstallation of product
 3. Service performed by anyone other than Rockford or an Authorized Rockford Fosgate Service Center
 4. Any product which has had the serial number defaced, altered, or removed
 5. Subsequent damage to other components
 6. Any product purchased outside the U.S.
 7. Any product not purchased from an Authorized Rockford Fosgate Dealer
- **Limit on Implied Warranties**

Any implied warranties including warranties of fitness for use and merchantability are limited in duration to the period of the express warranty set forth above. Some states do not allow limitations on the length of an implied warranty, so this limitation may not apply. No person is authorized to assume for Rockford Fosgate any other liability in connection with the sale of the product.
- **How to Obtain Service**

Please call 1-800-669-9899 for Rockford Customer Service. You must obtain an RA# (Return Authorization number) to return any product to Rockford Fosgate. You are responsible for shipment of product to Rockford.

Ship to: **Electronics**
Rockford Corporation
Warranty Repair Department
2055 E. 5th Street
Tempe, AZ 85281
RA#: _____

Ship to: **Speakers**
Rockford Acoustic Design
(Receiving-speakers)
609 Myrtle N.W.
Grand Rapids, MI 49504
RA#: _____

International Information

ESPAÑOL

LEA DETENIDAMENTE LAS SIGUIENTES INSTRUCCIONES DE INSTALACION DEL PRODUCTO. EVITARA POSIBLES DAÑOS A VD., AL VEHICULO O AL PRODUCTO.

INTRODUCCION

Los ingenieros de Rockford han diseñado los amplificadores Punch para ofrecer en el difícil entorno de un automóvil una calidad de sonido superior en un producto flexible, fiable y eficiente. Trans•ana es un circuito de baja tensión en la etapa de preamplificación de los amplificadores Punch que permite que la música suene limpia y cristalina y muy real, incluso a altos niveles de audición. Esto se complementa con el TOPAZ, un circuito exclusivo de masa utilizado para eliminar los ruidos asociados con las instalaciones de car-audio. La flexibilidad esta garantizada con el uso de la XCard incorporada. La fiabilidad se refuerza con el uso de un circuito de protección llamado NOMAD, mientras que los MOSFET y la tecnología DSM (montaje discreto en superficie) aumentan la eficiencia del amplificador. La combinación de todos estos componentes dan al amplificador Punch una impresionante calidad de sonido en un chasis discreto.

UBICACIÓN PARA EL MONTAJE

Montaje en el Malatero

Monte el amplificador verticalmente con las líneas del radiador orientadas de arriba hacia abajo. De esta manera conseguira la mejor ventilación.

Montaje en el Compartimento de Pasajeros

El montaje en el compartimento de pasajeros sera eficiente en función de la ventilación que tenga el amplificador. Si va a instalar el amplificador bajo un asiento deberá dejar al menos 2.5cm libres sobre la carcasa del amplificador.

Instalacion

Por seguridad, desconecte el terminal negativo de la batería antes de comenzar la instalación.

Terminal B+

El cable B+ debe ir provisto de un fusible a una distancia no mayor de 45cm de la batería. Prepare el cable e instale el portafusibles en el compartimento del motor. Las conexiones han de ser impermeables.

Terminal GND

Prepare un trozo de cable para usarlo como toma de masa. Prepare un punto de masa en el chasis raspando y eliminando la pintura de la superficie de metal y limpielo de toda suciedad asegure el cable al chasis con un tornillo.

Terminal REM

Conecte el cable REM a un punto de +12V conmutable. La señal se suele coger de la salida auto antena del radio cassette si este no tiene salida remote.

Funcionamiento Estereo

Punch 200, 4-canales

Punch 400, 4-canales

Punch 600, 4-canales

Punch 800, 4-canales

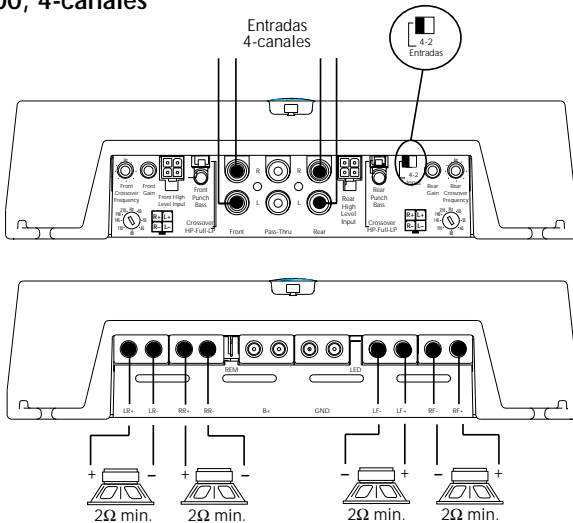

Funcionamiento Estereo
Punch 600, 5-canales

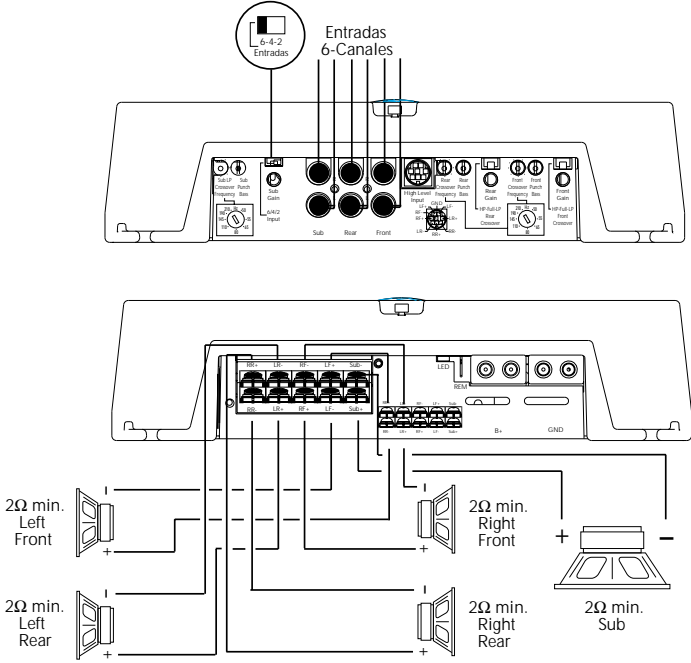

FRANÇAIS

ATTENTION: Veuillez lire les instructions suivantes pour l'installation de cet amplificateur. Ne pas les suivre pourrait causer des blessures ou endommager le véhicule.

INTRODUCTION

Les ingénieurs de Rockford Fosgate ont conçu l'amplificateur Punch pour supporter l'environnement rude de l'automobile en délivrant une qualité de son supérieure dans un ensemble efficace, fiable et flexible. Trans•ana est un circuit de bas voltage dans l'étage de préamplification de tous les amplificateurs Punch qui reproduit un son musical clair comme du cristal et très réel, même à très haut volume. Ceci est accompagné du TOPAZ, un circuit unique employé pour éliminer les problèmes de bruits parasites associés aux systèmes audiobile et leur installation. La flexibilité est assurée par l'emploi d'une XCard incorporée.

La fiabilité est garantie grâce au circuit de protection NOMAD, la technologie MOSFET et DSM (Composants Montés en Surface) améliorent l'efficacité de l'amplificateur.

L'ensemble de ces atouts donne à l'amplificateur Punch une qualité de son inégalable sous une carrosserie "pare-balles".

MONTAGE

Montage dans le coffre

Monter l'amplificateur verticalement avec les rainures de haut en bas ce qui lui permet de refroidir plus facilement.

Montage dans l'habitacle

Monter l'amplificateur dans l'habitacle ne pose aucun problème, du moment qu'il y ait assez d'air pour le refroidir. Si vous montez l'ampli en dessous du siège, prévoyez 2.5 cm d'air autour du radiateur.

Installation

Pour votre sécurité, déconnectez la borne négative de la batterie du véhicule avant de commencer l'installation.

Terminal B+

Il est impératif qu'il y ait un fusible sur le câble pour la connexion à la masse. Préparez le châssis en grattant la peinture de la surface métallique et nettoyez la saleté et l'huile. Attachez le câble au châssis avec une vis.

Terminal GND

Préparez une longueur de câble pour la connexion à la masse. Préparez le châssis en grattant la peinture de la surface métallique et nettoyez la saleté et l'huile. Attachez le câble au châssis avec une vis.

Terminal REM

Connectez le fil REM à une commande 12 volts positive de la source. La commande 12 volts est habituellement prise sur la sortie antenne électrique de la source ou la commande accessoire. Si la source ne dispose pas de ces sorties, nous vous recommandons d'installer un interrupteur qui fournira un positif 12 volts au REM de l'amplificateur.

Opération stéréo

Punch 200, 4-canaux

Punch 400, 4-canaux

Punch 600, 4-canaux

Punch 800, 4-canaux

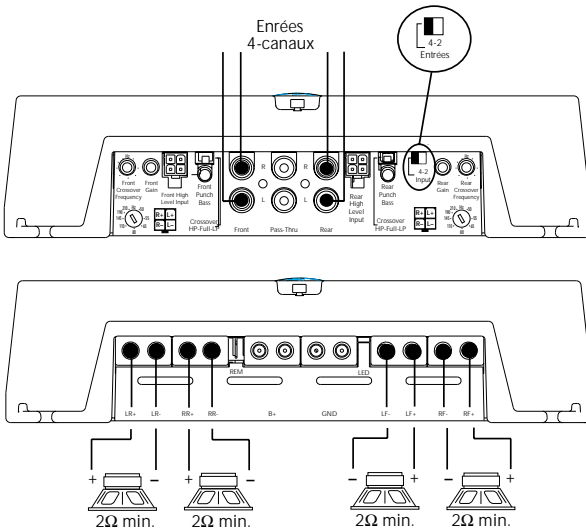

**Opération stéréo
Punch 600, 5-canaux**

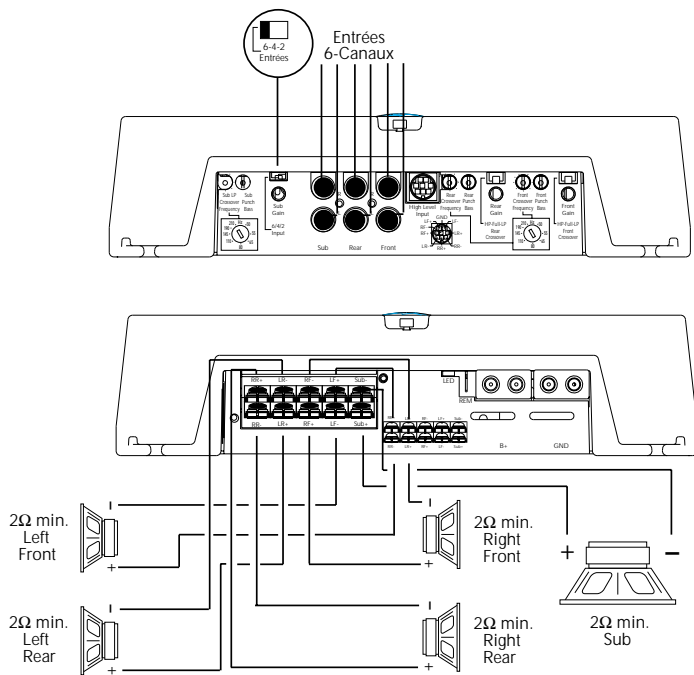

BITTE LESEN SIE DIESE GEBRAUCHSANLEITUNG ZUERST SORGFÄLTIG DURCH. DAS KANN SIE VOR DEM FALSCHEN EINSATZ, AUSFALLEN ODER SOGAR BESCHÄDIGUNG DES PRODUKTES ODER IHRES FAHRZEUGES SCHÜTZEN.

EINLEITUNG

Rockford Ingenieure haben die Punch Verstärker entwickelt. Mit höchstem Technologie-Standart, hervorragender Klangqualität, einfacher Handhabung und bester Servicefreundlichkeit Trans•ana ist eine Nieder-Volt Schaltung im Vorverstärkerteil aller Püch Verstärker die für kristallklaren Klang auch bei sehr hohen Lautstärken sorgt. TOPAZ, eine einzigartige Erdungsschaltung verhindert und unterdrückt Einstreuungen und Störungen die nur allzu oft Car Audio Systeme beeinträchtigen. Flexibilität durch die Vielfalt der Aktivweiche mit ihren XCards, lange Lebensdauer durch die Schutzschaltung NOMAD und der Einsatz von MOSFET Transistoren und DSM (Discrete Surface Mount), machen diese Verstärker so effizient. Das Ergebnis all dieser Komponenten machen Punch-Verstärker so einzigartig und in ihrer Klangqualität nahezu unschlagbar.

EINBAUORT

Im Fahrzeugkofferraum

Der vertikale Einbau der Endstufen, das bedeutet, daß die Kühlrippen von oben nach unten verlaufen, gibt dem Verstärker die beste Kühlung.

Auf der Beifahrerseite

Sollte der Verstärker auf der Beifahrerseite montiert werden, so ist es sehr wichtig, für eine ausreichende Kühlung zu sorgen. Sollte der Verstärker z.B. unter dem Beifahrersitz montiert werden, sollte dem Kühlkörper mindestens ein Luftspalt von 2.5 cm bleiben, um so für eine ausreichende Kühlung zu sorgen.

Einbau

Zur Sicherheit klemmen Sie den Negativ-Pol der Batterie während des gesamten Einbaues ab.

B+ Anschluß

Die Plus-Leitung MUß ca. 45 cm nach dem Plus-Pol der Batterie abgesichert sein. Preparieren Si die Kabellängen und montieren Sie den Sicherungshalter im Motorraum. ALLE Verbindungen müssen wasserdicht sein.

GND Anschluß

Preparieren Sie Ihr Kabel für die Negativ Leitung (Erdung). Preparieren Sie die Anschlußstelle des Erdungskabels, indem Sie das Metall gründlich reinigen und vom Lack befreien. Befestigen Sie nun die Erdung an dieser Stelle mit einer Schraube.

REM Anschluß

Verbinden Sie das Ein- und Ausschaltungskontroll-Kabel mit Ihrem Radio (12 Volt positiv). Normalerweise verwenden Sie hierfür die Ant.-Remote Ihres Radios oder ein eigens dafür vorgesehenes Kabel (Amp-Remote). Sollte Ihr Radio diesen Anschluß nicht besitzen, so verwenden Sie eine 12 Volt Spannung, die Sie durch einen Schalter ein- und ausschalten können.

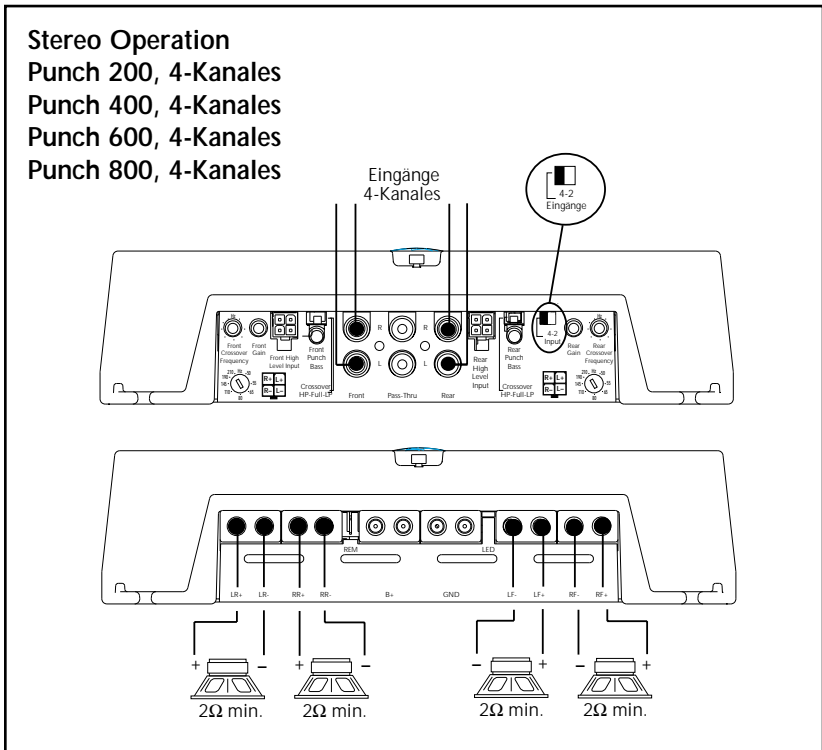

Stereo Operation
Punch 600, 5-Kanales

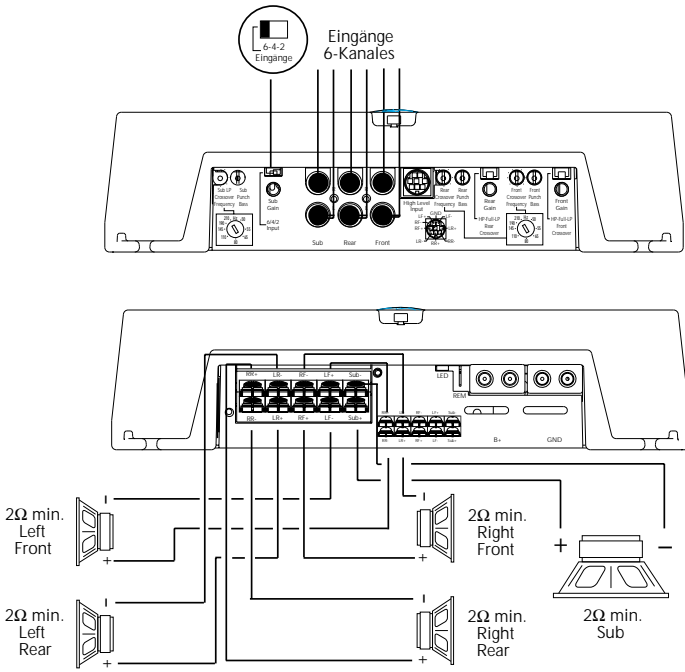

ATTENZIONE: SI PREGA DI LEGGERE LE SEGUENTI ISTRUZIONI PER L'INSTALLAZIONE DI QUESTO PRODOTTO. IL NON SEGUIRLE POTREBBE RISULTARE SERIAMENTE DANNOSO PER LA PERSONA O PER IL VEICOLO.

INTRODUZIONE

Gli ingegneri Rockford hanno progettato la serie di amplificatori Punch per resistere all'ostico ambiente automobilistico mentre suonano con una musicalità superiore, offrendo un insieme versatile, affidabile ed efficiente. Trans•ana é un circuito a bassa tensione dello stadio preamplificatore del Punch che permette al suono di essere cristallino e reale anche in presenza di volumi molto elevati... tutto questo é accoppiato TOPAZ, un esclusivo circuito di massa impiegato per eliminare i problemi di rumore comunemente presenti negli impianti car audio. Il massimo della versatilità é raggiunto con l'impiego delle XCard. L'affidabilità é completamente garantita dall'impiego di un circuito di protezione chiamato NOMAD, mentre l'uso di MOSFET e della tecnologia DSM (Discrete Surface Mount) permette di raggiungere efficienze elevatissime. Il risultato finale di tutte queste tecnologie moderne é che gli amplificatori Punch suonano meravigliosamente e sono indistruttibili, a "prova di proiettile."

DOVE POSIZIONARLO

Nel Bagagliaio

Montando l'amplificatore su una superficie in verticale con le alette direzionate dall'alto verso il basso si garantirá un miglior raffreddamento dell'amplificatore.

Nell'abitacolo

Montare l'amplificatore nell'abitacolo si avrá un funzionamento regolare se si garantisce un flusso d'aria sufficiente. Per l'installazione sotto un sedile, é necessario avere uno spazio di almeno 2.5 cm attorno a tutto l'amplificatore.

Installazione

Per sicurezza, scollegare il polo negativo della batteria dell'auto prima di iniziare l'installazione.

Terminale B+ (cavo positivo)

Il cavo positivo deve essere protetto da un fusibile a non più di 45 cm dalla batteria. Terminare il cavo e installare il fusibile nel vano motore. Tutte le connessioni devono essere a prova d'acqua.

Terminale GND (cavo negativo)

Decidere la lunghezza del cavo e terminarlo. Preparare la massa grattando la vernice dal telaio dell'auto ed eliminando tracce di olio o sporco. Fissare il cavo di massa al telaio con una vite.

Terminale REM (Consenso di accensione)

Collegare il cavo REM ad un positivo presente solo ad autoradio accesa (normalmente il cavo pilota dell'antenna elettrica o il cavo accessori dell'autoradio). Se la sorgente non dovesse essere equipaggiata con queste uscite, la soluzione raccomandabile é di inserire un interruttore su un cavo positivo e connettersi all'amplificatore.

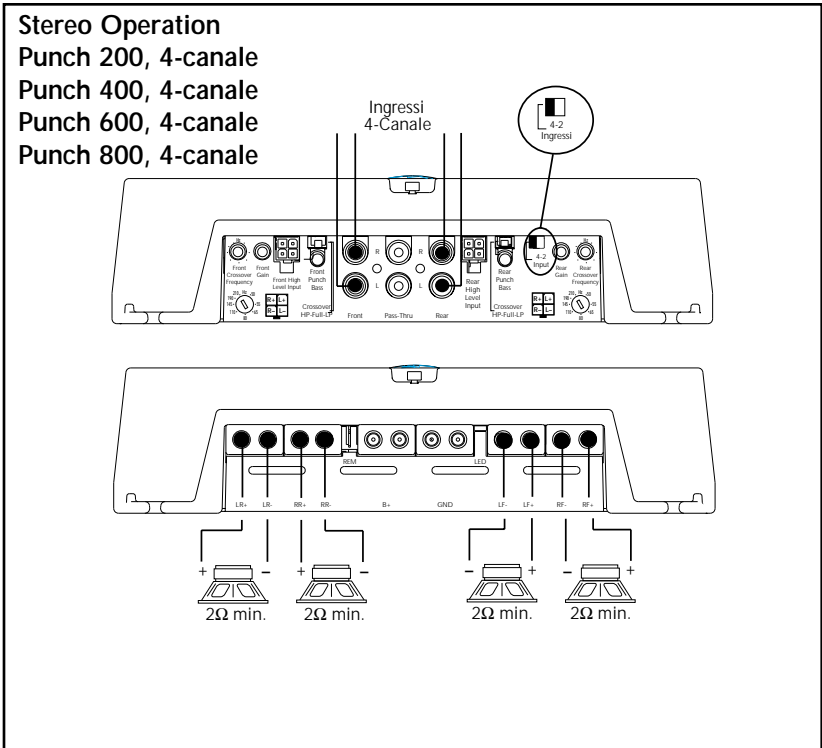

Stereo Operation
Punch 600, 5-canale

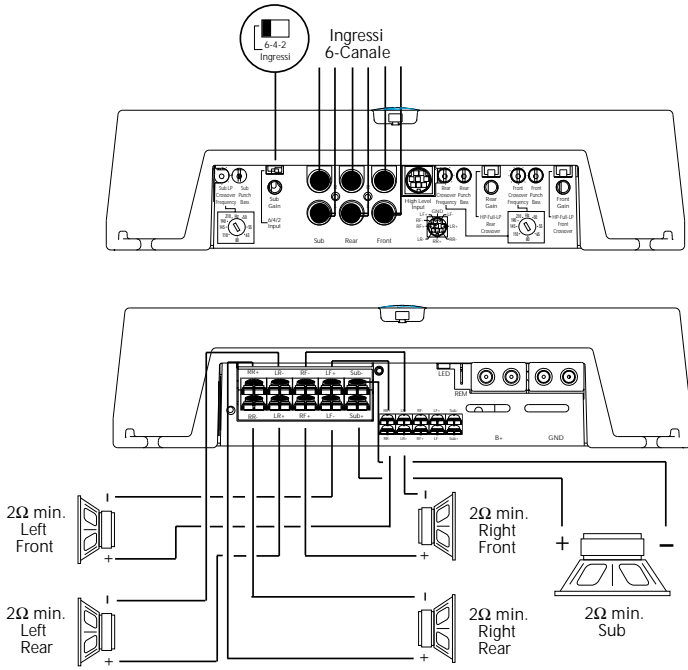

Installation assistance available at:

RFTECH

www.rockfordfosgate.com/rftech

MADE IN THE USA

This product is designed, developed and assembled in the USA by a dedicated group of American workers. The majority of the components used in the construction of this product are produced by American companies. However, due to the global nature of their manufacturing facilities and the loudspeaker parts industry in general, some parts may be manufactured in other countries.



Rockford Corporation
546 South Rockford Drive
Tempe, Arizona 85281 U.S.A.
In U.S.A., (480) 967-3565
In Europe, Fax (49) 8503-934014
In Japan, Fax (81) 559-79-1265